

TAURUS®

Assembly Instructions

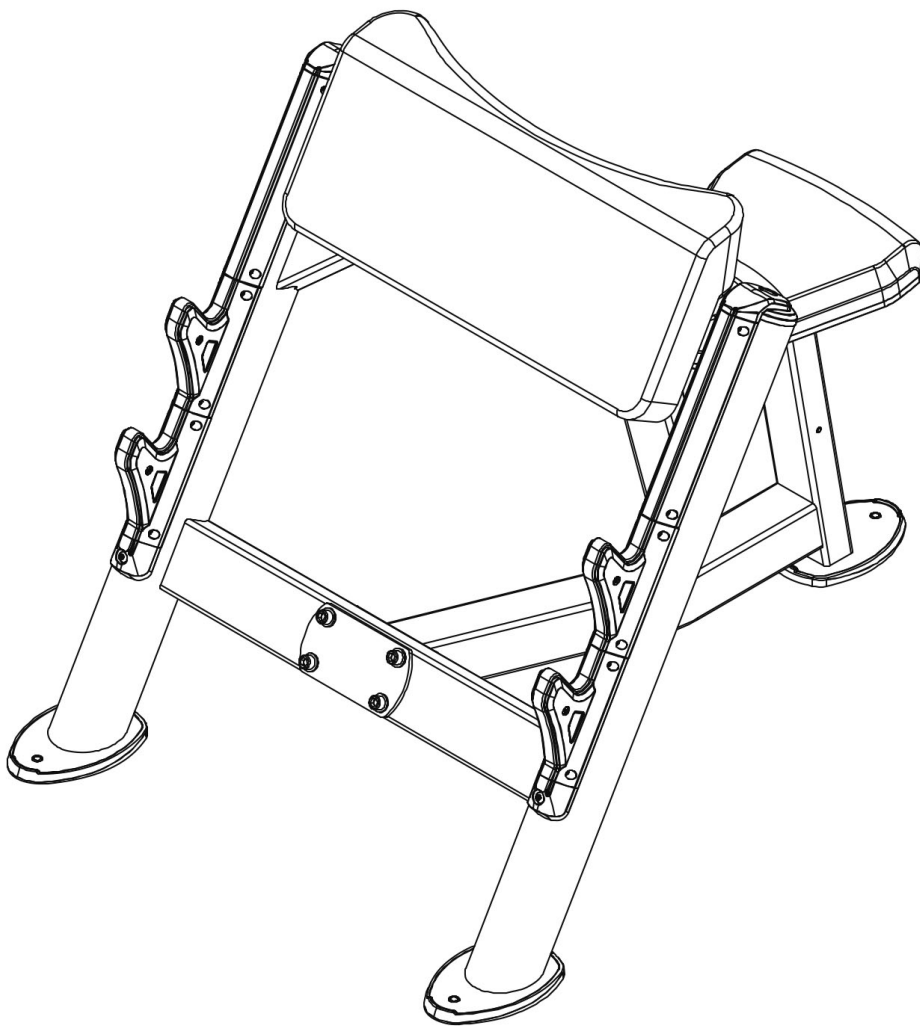

max. 240 kg



~ 30 Min.



45 kg
L 122 | W 86 | H 94

TFPTT0206.01.01

Art. No. TF-PTT0206

Taurus Studio Preacher Curl

Content

1	GENERAL INFORMATION	7
1.1	Technical Data	7
1.2	Personal Safety	8
1.3	Set-Up Place	9
2	ASSEMBLY	10
2.1	General Instructions	10
2.2	Scope of Delivery	11
2.3	Assembly	12
3	STORAGE AND TRANSPORT	14
3.1	General Instructions	14
4	TROUBLESHOOTING, CARE AND MAINTENANCE	15
4.1	General Instructions	15
4.2	Faults and Fault Diagnosis	15
4.3	Maintenance and Inspection Calendar	16
5	DISPOSAL	16
6	RECOMMENDED ACCESSORIES	17
7	ORDERING SPARE PARTS	18
7.1	Serial Number and Model Name	18
7.2	Parts List	19
7.3	Exploded Drawing	21
8	WARRANTY	22
9	CONTACT	24

Dear customer,

Thank you for choosing a high-quality equipment of the brand Taurus®. Taurus® offers sports and fitness equipment for the sophisticated home sport and the equipment of fitness studios and business customers. With Taurus® fitness equipment, the focus is on what sport is all about: maximum performance! Therefore, the equipment is developed in close consultation with athletes and sports scientists. Because athletes know best what makes perfect fitness equipment.

Further information can be found at www.sport-tiedje.com.

Intended Use

The equipment may only be used for its intended purpose.

This fitness equipment is suitable for home use, semi-professional use and commercial or professional use. The semi-professional sector includes, for example, institutional facilities such as hospitals, schools, hotels and associations. Professional use refers to commercial use, e.g. in a fitness studio.

Legal Notice

Sport-Tiedje GmbH
Europe's No. 1 for home fitness

International Headquarters
Flensburger Straße 55
24837 Schleswig
Germany

Management:
Christian Grau
Sebastian Campmann
Dr. Bernhard Schenkel
No. HRB 1000 SL
Local Court Flensburg
European VAT Number: DE813211547

Disclaimer



©2011 Taurus® is a registered brand of the company SportTiedje GmbH. All rights reserved. Any use of this trademark without the explicit written permission of Sport-Tiedje is prohibited.

Product and manual are subject to change. Technical data can be changed without advance notice.

ABOUT THIS MANUAL

Please carefully read the entire manual before installation and first use. The manual will help you to quickly set up the system and explains how to safely use it. Make sure that all persons exercising with the equipment (especially children and persons with physical, sensory, mental or motor disabilities) are informed about this manual and its contents in advance. In case of doubt, responsible persons must supervise the use of the equipment.



This equipment has been manufactured according to the latest safety knowledge. As far as possible, potential safety hazards which could cause injury have been eliminated. Make sure to carefully follow the instructions and that all parts are securely in place. If required, read through the instructions again to correct any mistakes.

Please pay close attention to the safety and maintenance instructions given here. The contract partner cannot be held liable for damage to health, accidents or damage to the equipment when it is not used in accordance with these instructions.

The following safety instructions may appear in this manual:

► **ATTENTION**

This notice indicates potentially hazardous situations which, if not avoided, may result in property damage.

⚠ **CAUTION**

This notice indicates potentially hazardous situations which, if not avoided, may result in slight or minor injuries!

⚠ **WARNING**

This notice indicates potentially hazardous situations which, if not avoided, may result in death or serious injuries!

⚠ **DANGER**

This notice indicates potentially hazardous situations which, if not avoided, will result in death or serious injuries!

ⓘ **NOTICE**

This notice indicates further useful information.

Retain these instructions in a safe place for future reference, maintenance or when ordering replacement parts.

1.1 Technical Data

Weight and Dimensions:

Packaging dimensions (L x W x H) and weight approx.:

Box 1: 105 cm x 90 cm x 24.5 cm 44 kg

Box 2: 66 cm x 18 cm x 42 cm 6.4 kg

Article weight (net, excl. packaging) approx.: 45.3 kg

Set-up dimensions (L x W x H) approx.: 122 cm x 86 cm x 94 cm

Maximum total load: 240 kg

1.2 Personal Safety

DANGER

- + Before you start using the equipment, you should consult your physician that this type of exercise is suitable for you from a health perspective. Particularly affected are persons who: have a hereditary disposition to high blood pressure or heart disease, are over the age of 45, smoke, have high cholesterol values, are overweight and/or have not exercised regularly in the past year. If you are under medical treatment that affects your heart rate, medical advice is absolutely essential.
- + Note that excessive training can seriously endanger your health. Please also note that heart rate monitoring systems can be inaccurate. If you notice any signs of weakness, nausea, dizziness, pain, shortness of breath, or other abnormal symptoms, stop exercising immediately and seek advice from your doctor if necessary.

WARNING

- + This equipment may not be used by children under the age of 14.
- + Children should not be allowed unsupervised access to the equipment.
- + Persons with disabilities must have a medical license and must be under strict observation when using the equipment.
- + The equipment is strictly for use by one person at a time.
- + If your equipment provides a safety key, the clip of the safety key must be attached to your clothing before starting your training. In the event of a fall, the EMERGENCY STOP of the equipment can be initiated.
- + Keep your hands, feet and other body parts, hair, clothing, jewellery and other objects well clear of moving parts.
- + During use, wear suitable sports clothing rather than loose or baggy clothing. When wearing sports shoes, make sure they have suitable soles, preferably made of rubber or other non-slip materials. Shoes with heels, leather soles, studs or spikes are unsuitable. Never exercise barefoot.

CAUTION

- + If your equipment needs to be connected to the power supply with a mains cable, make sure that the cable is not a potential tripping hazard.
- + Make sure that nobody is within the range of motion of the equipment during training so as not to endanger you or other persons.

ATTENTION

- + Do not insert any objects of any kind into the openings of the device.

1.3 Set-Up Place

WARNING

- + Do not place the equipment in main corridors or escape routes.

CAUTION

- + Choose a location in which to place the equipment such that there is enough free space/clearance to the front, the rear and to the sides of the equipment.
- + The training room should be well ventilated during training and not be exposed to any draughts.
- + Choose the place in which to set up the equipment such that there is enough free space/clearance to the front, the rear and to the sides of the equipment.
- + The set-up and mounting surface of the equipment should be flat, loadable and solid.

ATTENTION

- + The device may only be used in one building, in sufficiently tempered and dry rooms (ambient temperatures between 10°C and 35°C). The equipment should not be used outdoors or in rooms with high humidity (over 70%) like swimming pools.
- + A floor protective mat/equipment underlay can help to protect high-quality floor coverings (parquet, laminate, cork, carpets) from dents and sweat and can help to level out slight unevenness.

2.1 General Instructions

⚠ DANGER

- + Do not leave any tools, packaging materials such as foils or small parts lying around, as otherwise there is a danger of suffocation for children. Keep children away from the equipment during assembly.

⚠ WARNING

- + Pay attention to the instructions attached to the equipment in order to reduce the risk of injuries.

⚠ CAUTION

- + Ensure to have sufficient room for movement in each direction during assembly.
- + The assembly of the equipment must be carried out by at least two adults. If in doubt, seek the help of a third technically skilled person.

▶ ATTENTION

- + To prevent damage to the equipment and the floor, assemble the equipment on a mat or packaging board.

ⓘ NOTICE



- + In order to make the assembly as simple as possible, some screws and nuts to be used can already be pre-assembled.
- + Ideally, assemble the equipment at its later set-up place.

2.2 Scope of Delivery

The scope of delivery consist of the following parts. At the beginning, check whether all parts and tools belonging to the device are included in the scope of delivery and whether damage has occurred. In the event of complaints, the contractual partner must be contacted directly.

⚠ CAUTION

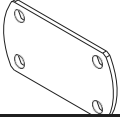
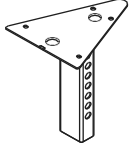
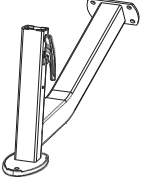
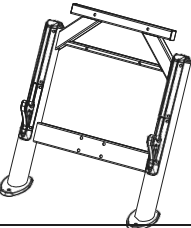
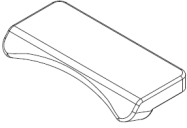
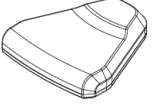
If parts of the scope of delivery are missing or damaged, the assembly must not be carried out.

ITEM NO.	NAME.		QTY.
6	Junction Plate		1
3	Seat Pad Frame		1
2	Support Frame		1
1	Arm Support Frame		1
35	Arm Pad		1
36	Seat Pad		1
	HARDWARE PACK		1

2.3 Assembly

Before assembly, take a close look at the individual assembly steps shown and carry out the assembly in the order given.

① NOTICE

First loosely screw all parts together and check that they fit properly. Tighten the screws using the tool only when you are instructed to do so.

Step 1: Assembly of the Arm Support Frame and the Support Frame

1. Place the support frame (2) on the back side of the arm support frame (1) by aligning the holes with each other.
2. Mount the junction plate (6) through the holes of the arm support frame (1) onto the support frame (2) with four screws (28) and four plain washers (30).
3. Secure the screw joints on the support frame (2) with four nuts (27) and four plain washers (30).

No.	Name	Specification	Qty.
1	Arm support frame		1
2	Support frame		1
6	Junction plate		1
27	Nylon insert lock nut	M112	4
28	Hex socket head cap screw	M12*80	4
30	Plain washer	Φ24*Φ13*2.5	8

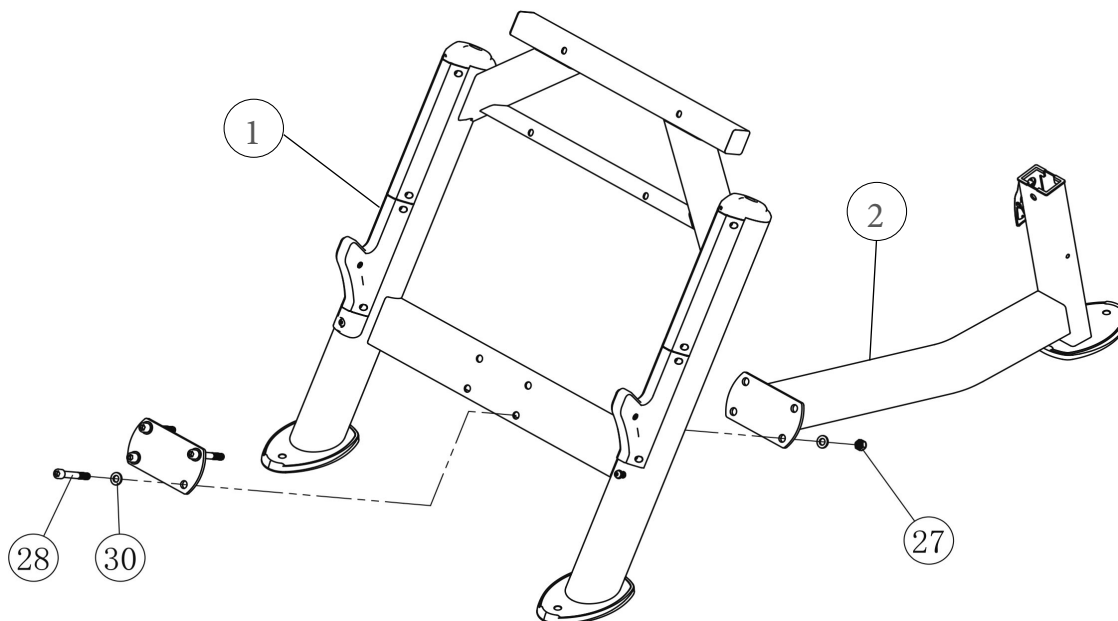

Step 2: Assembly of the Arm Pad and Seat Pad

1. Mount the arm pad (35) onto the arm support frame (1) with two screws (26), two spring washers (31) and two plain washers (29).
2. Insert the seat pad frame (3) into the support frame (2).
3. Mount the seat pad frame (3) onto the support frame (2) with one screw (10) and one spring washer (32).
4. Mount the seat pad (36) onto the seat pad frame (3) with four screws (25), four spring washers (31) and four plain washers (29).

No.	Name	Specification	Qty.
1	Arm support frame		1
2	Support frame		1
3	Seat pad frame		1
35	Arm pad		1
36	Seat pad		1
10	Limiting screw		1
25	Hexagon socket button head screw	M8*30	4
26	Hex socket head cap screw	M8*75	2
29	Plain washer	Φ16*Φ8.4*1.6	6
31	Spring washer	M8	6
32	Spring washer	M10	1

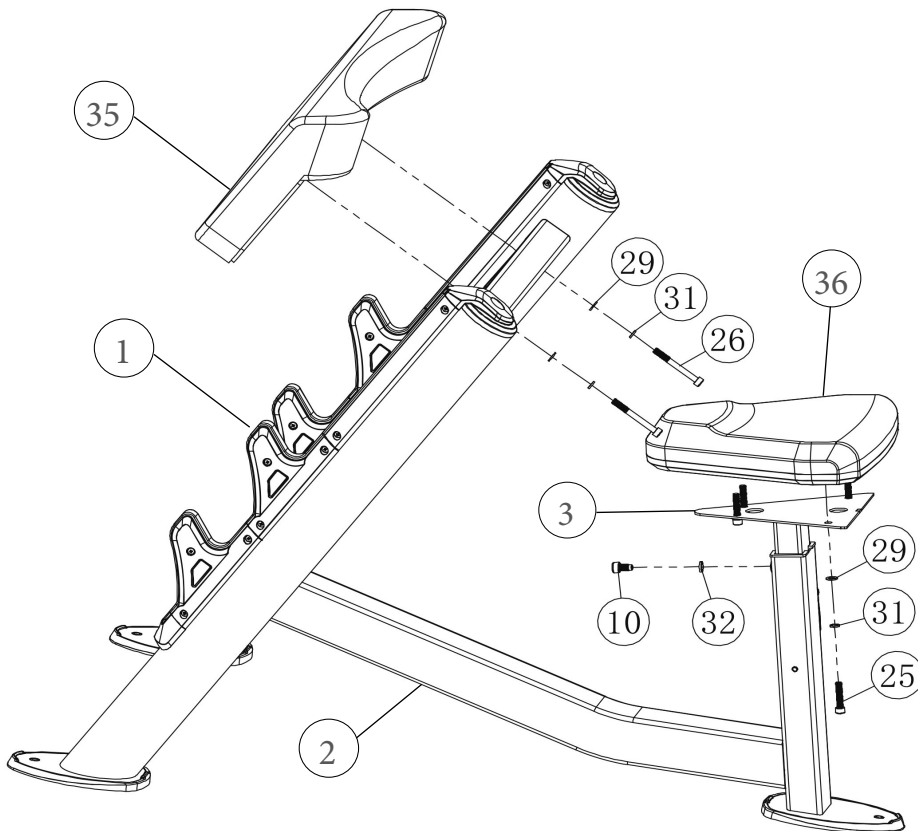

3.1 General Instructions

⚠ WARNING

- + The storage location should be chosen so that improper use by third parties or children can be prevented.
- + If your equipment does not have transportation wheels, the equipment must be disassembled before transportation.

▶ ATTENTION

- + Make sure that the equipment is protected from moisture, dust and dirt in the selected storage location. The storage location should be dry and well ventilated and have a constant ambient temperature between 10°C and 35°C.

4.1 General Instructions

WARNING

- + Do not make any improper changes to the equipment.

CAUTION

- + Damaged or worn components may affect your safety and the life of the equipment. Therefore, immediately replace damaged or worn components. In such a case, contact the contract partner. The equipment must not be used until it has been repaired. If necessary, use only original spare parts.

ATTENTION

- + In addition to the instructions and recommendations for maintenance and care given here, additional service and/or repair work may be necessary; this must only be carried out by authorised service technicians.

4.2 Faults and Fault Diagnosis

The equipment undergoes regular quality controls during production. Nevertheless, faults or malfunctions may occur. Frequently, individual parts are responsible for these disturbances, an exchange is usually sufficient. Please refer to the following overview for the most common errors and how to correct them. If the equipment still does not function properly, contact your contract partner.

Fault	Cause	Solution
Squeaking & cracking noises	Screw connections loosened or too tight	Check screw connections

4.3 Maintenance and Inspection Calendar

To avoid damage from body sweat, the equipment must be cleaned with a damp towel (no solvents!) after each training session.

The following routine tasks must be performed at the specified intervals:

Part	Weekly	Monthly	Quarterly
Screw connections		I	
Cushions	C	I	
Legend: C = clean; I = inspect			

5 DISPOSAL

At the end of its operational life, this equipment cannot be disposed of in normal household waste. Instead, it must be disposed of via a recycling centre. Further information can be obtained from your local authority's recycling service.

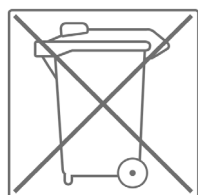

The materials can be recycled as per their symbols. Through the reuse, recycling of materials or other forms of recovery of old equipment, you make an important contribution to the protection of the environment.

6 RECOMMENDED ACCESSORIES

To make your training experience even more efficient and pleasant, we recommend that you add suiting accessories to your fitness equipment. This could be a floor mat, for example, which makes your fitness equipment stand more securely and also protects the floor from falling sweat, but it could also be additional handrails on some treadmills or silicone spray to keep moving parts in good shape.

If you have purchased a fitness machine with pulse training and want to train your heart rate, we strongly recommend that you use a compatible chest strap, as this ensures optimum transmission of the heart rate. You may want to buy additional grips or weights for multi gyms.

Our range of accessories offers the highest quality and makes training even better. If you would like to find out more about compatible accessories, please go to the detail page of the product in our webshop (the easiest way is to enter the article number in the search field above) and go to the recommended accessories on this page. Of course, you can also contact our customer service: by telephone, e-mail, in one of our branches or via our social media channels. We will be happy to advise you!



floor mat



chest strap



chest strap contact gel



towels



silicone spray

7.1 Serial Number and Model Name

In order to provide you with the best possible service, please have the model name, article number, serial number, exploded drawing and parts list ready. The corresponding contact options can be found in chapter 9 of this operating manual.

NOTICE

The serial number of your equipment is unique. It's located on a white sticker. The exact position of this sticker is shown in the following illustration.

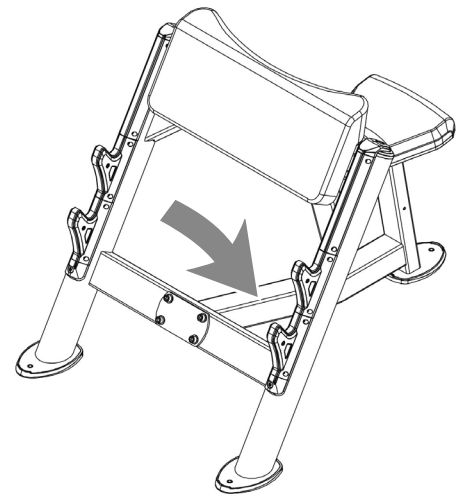

Enter the serial number in the appropriate field.

Serial number:

Brand / Category:

Taurus / weight bench

Model Name:

Studio Preacher Curl

Article Number:

TF-PTT0206

7.2 Parts List

No.	Name	Specification	Qty.
1	Arm support frame		1
2	Support frame		1
3	Seat pad frame		1
6	Junction plate		1
7	Adjusting handlebar		1
8	Fixed axle		1
9	Torsion spring		1
10	Limiting screw		1
11	Semi-sliding sleeve		2
12	Pipe plug		2
13	Left hook jacket		4
14	Middle hook jacket		4
15	Right hook jacket		4
16	Left extend jacket		2
17	Middle extend jacket		2
18	Right extend jacket		2
19	Lower protecting jacket		2
20	Upper protecting jacket		2
21	Rubber mat		3
22	Split washer	d=6	2
23	Small countersunk head rivet nut	M8*18	2
24	Cross head modified truss head screw	M5*12	32
25	Hexagon socket button head screw	M8*30	4
26	Hex socket head cap screw	M8*75	2
27	Nylon insert lock nut	M12	4
28	Hex socket head cap screw	M12*80	4
29	Plain washer	Φ16*Φ8.4*1.6	10
30	Plain washer	Φ24*Φ13*2.5	8

31	Spring washer	M8	10
32	Spring washer	M10	1
33	Hex socket head cap screw	M8*40	4
34	hole plug		2
35	Arm pad		1
36	Seat pad		1

7.3 Exploded Drawing

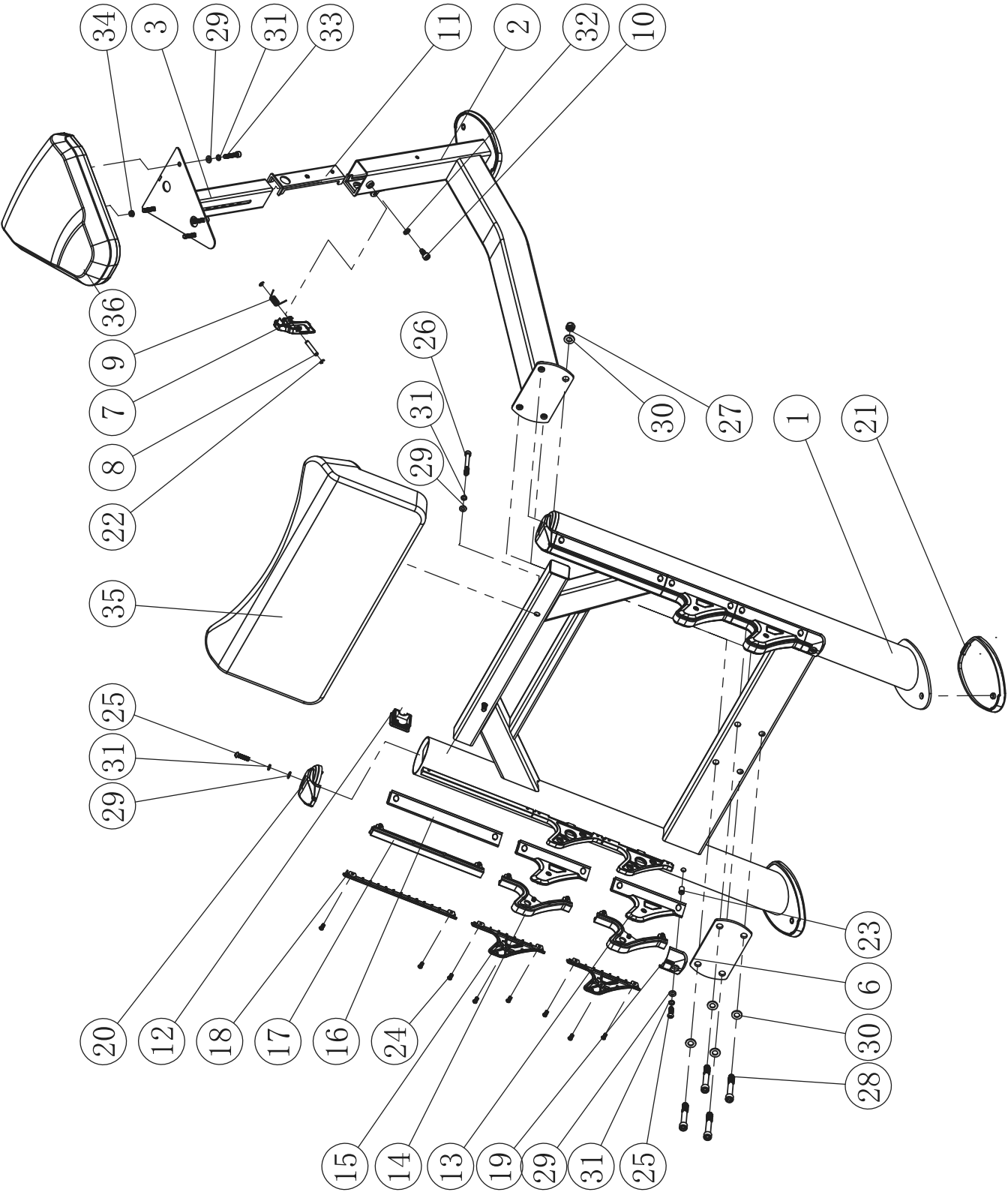

Training equipment from Taurus® is subject to strict quality control. However, if a fitness equipment purchased from us does not work perfectly, we take it very seriously and ask you to contact our customer service as indicated. We are happy to help you by phone via our service hotline.

Error Descriptions

Your fitness equipment is developed for long-term, high-quality training. However, should a problem arise, please first read the operating instructions. For further assistance, please contact your contract partner or call our service hotline. To ensure your problem is solved as quickly as possible, please describe the defect as exactly as possible.

In addition to the statutory warranty, we provide a warranty for every fitness equipment purchased from us according to the following provisions.

Your statutory rights are not affected.

Warranty

The warranty is the first/original buyer and/or any person who received a newly purchased product as a gift from the original buyer.

Warranty period

The warranty periods, shown on our web shop, begin on delivery of the fitness equipment. The respective warranty periods for your equipment can be found on its product website.

Repair Costs

According to our choice, there will either be a repair, a replacement of individual damaged parts or a complete replacement. Spare parts, that have to be mounted while assembling the equipment, have to be replaced by the warranty personally and are not a part of repair. After the expiration of the warranty period for repair costs, a pure parts warranty applies, which does not include the repair, installation and delivery costs.

The terms of use are defined as follows:

- + Home use: solely for private use in private households up to 3 hours per day
- + Semi-professional use: up to 6 hours per day (e. g. rehabilitation centres, hotels, clubs, company gyms)
- + Professional use: more than 6 hours per day (e. g. commercial gyms)

Warranty Service

Within the warranty period, equipment which develops faults as a result of material or manufacturing defects, will be repaired or replaced at our discretion. Ownership of equipment or parts of equipment which have been replaced is transferred to us. The warranty period is not extended nor does a new warranty period begin following repair or replacement under the warranty.

Warranty Conditions

For the warranty to be valid, the following steps must be taken:

Please contact our customer service by email or phone. If the product under warranty has to be sent in for repair, the seller bears costs. After expiry of the warranty, the buyer bears the costs of transport and insurance. If the fault is covered by our warranty, you will receive a new or repaired equipment in return.

Warranty claims are invalid in case of damage resulting from:

- + misuse or improper handling
- + environmental influences (moisture, heat, electrical surge, dust, etc.)
- + failure to follow the current safety measures for the equipment
- + failure to follow the operating instructions
- + use of force (e. g. hitting, kicking, falling)
- + interventions which were not carried out by one of our authorized service centres
- + unauthorised repair attempts

Proof of Purchase and Serial Number

Please make sure that you are able to provide the appropriate receipt when claiming on your warranty. So that we can clearly identify the model of your equipment, and for the purposes of our quality control, you will need to give the serial number of your equipment, when contacting the service team. Where possible please have your serial number and your customer number ready when you call our service hotline. It will help us to deal with your request swiftly.



































If you cannot find the serial number on your fitness equipment, our service team is at your disposal to offer further information.

Service outside of the Warranty Period

We are also happy to issue an individual cost estimate if there is a problem with your fitness equipment after the warranty has expired, or in cases which do not fall under the terms of the warranty, e. g. normal wear and tear. Please contact our customer service team to find a quick and cost-effective solution to your problem. In such a case you will be responsible for the delivery costs.

Communication

Many problems can be solved just by speaking to us as your specialist supplier. We know how important it is to you as a user of the fitness equipment to have problems solved quickly and simply, so you can enjoy working out with minimal interruption. For that reason, we also want to resolve your queries quickly and in a straightforward manner. Thus, please always keep your customer number and the serial number of the faulty equipment handy.

DE	DK	FR
<p>TECHNICAL SUPPORT</p> <p> +49 4621 4210-900</p> <p> +49 4621 4210-698</p> <p> technik@sport-tiedje.de</p> <p> Mo - Fr 08:00 - 18:00 Sa 09:00 - 18:00</p> <p>SERVICE</p> <p> 0800 20 20277 (Freecall)</p> <p> info@sport-tiedje.de</p> <p> Mo - Fr 08:00 - 21:00 Sa 09:00 - 21:00 So 10:00 - 18:00</p>	<p>TECHNICAL SUPPORT & SERVICE</p> <p> 80 90 16 50</p> <p>+49 4621 4210-945</p> <p> info@fitshop.dk</p> <p> Mo - Fr 08:00 - 18:00 Sa 09:00 - 18:00</p>	<p>TECHNICAL SUPPORT & SERVICE</p> <p> +33 (0) 172 770033</p> <p>+49 4621 4210-933</p> <p> service-france@fitshop.fr</p> <p> Mo - Fr 08:00 - 18:00 Sa 09:00 - 18:00</p>
	PL	BE
	<p>TECHNICAL SUPPORT & SERVICE</p> <p> 22 307 43 21</p> <p>+49 4621 42 10-948</p> <p> info@fitshop.pl</p> <p> Mo - Fr 08:00 - 18:00 Sa 09:00 - 18:00</p>	<p>TECHNICAL SUPPORT & SERVICE</p> <p> 02 732 46 77</p> <p>+49 4621 42 10-932</p> <p> info@fitshop.be</p> <p> Mo - Fr 08:00 - 18:00 Sa 09:00 - 18:00</p>
UK	NL	INT
<p>TECHNICAL SUPPORT</p> <p> +44 141 876 3986</p> <p> support@powerhousefitness.co.uk</p> <p>SERVICE</p> <p> +44 141 876 3972</p> <p> Mo - Fr 9am - 5pm</p>	<p>TECHNICAL SUPPORT & SERVICE</p> <p> +31 172 619961</p> <p> info@fitshop.nl</p> <p> Ma - Do 09:00 - 17:00 Vr 09:00 - 21:00 Za 10:00 - 17:00</p>	<p>TECHNICAL SUPPORT & SERVICE</p> <p> +49 4621 4210-944</p> <p> service-int@sport-tiedje.de</p> <p> Mo - Fr 8am - 6pm Sat 9am - 6pm</p>
	AT	CH
	<p>TECHNICAL SUPPORT & SERVICE</p> <p> 0800 20 20277 (Freecall)</p> <p>+49 4621 42 10-0</p> <p> info@sport-tiedje.at</p> <p> Mo - Fr 08:00 - 18:00 Sa 09:00 - 18:00</p>	<p>TECHNICAL SUPPORT & SERVICE</p> <p> 0800 202 027</p> <p>+49 4621 42 10-0</p> <p> info@sport-tiedje.ch</p> <p> Mo - Fr 08:00 - 18:00 Sa 09:00 - 18:00</p>

Please find a detailed overview including address and opening hours for all stores of the Sport-Tiedje Group in Germany and abroad on the following website:

www.sport-tiedje.com/en/stores

WE LIVE FITNESS

WEBSHOP AND SOCIAL MEDIA

Sport-Tiedje is Europe's largest specialist store for home fitness equipment with currently over 70 stores and one of the world's most renowned online mail order companies for fitness equipment. Private customers order via the 25 web shops in the respective national language or have their desired equipment assembled on site. In addition, the company supplies fitness studios, hotels, sports clubs, companies and physio practices with professional equipment for endurance and strength training.

Sport-Tiedje offers a wide range of fitness equipment from renowned manufacturers, high-quality in-house developments and comprehensive services, such as a build-up service and sports scientific advice before and after the purchase. The company employs numerous sports scientists, fitness trainers and competitive athletes.

Visit us also on our social media platforms or our blog!

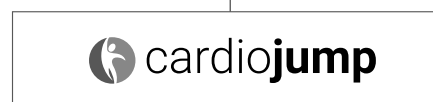
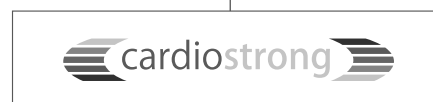
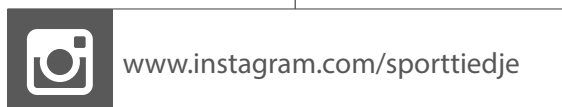

Notes

A large grid of graph paper for taking notes, consisting of 30 columns and 40 rows of small squares.

TAURUS[®]

Taurus Studio Preacher Curl