

EXPLODED DRAWING A

Model No. PFTL12820-INT.2 R0521A

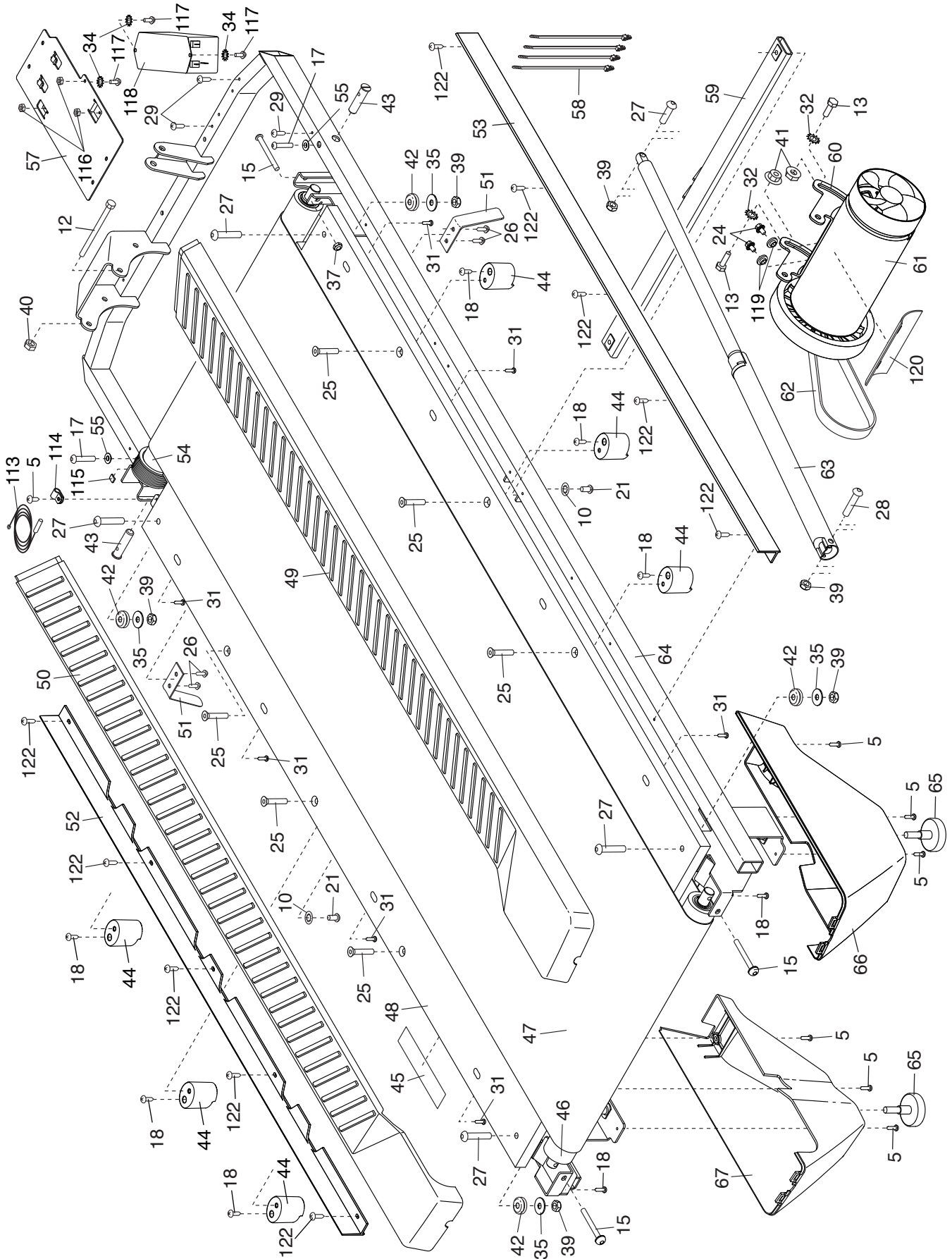

EXPLODED DRAWING B

Model No. PFTL12820-INT.2 R0521A

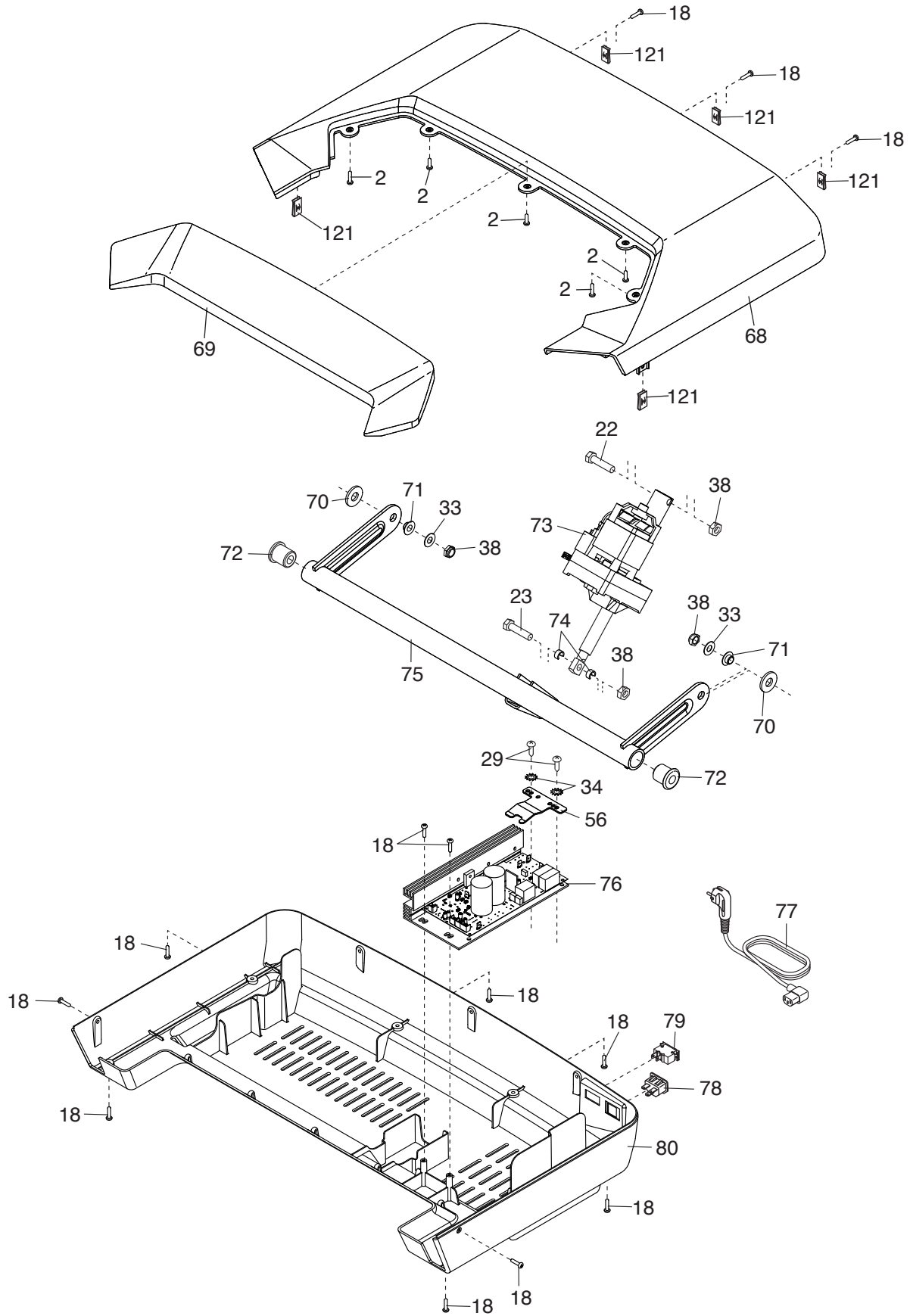

EXPLODED DRAWING C

Model No. PFTL12820-INT.2 R0521A

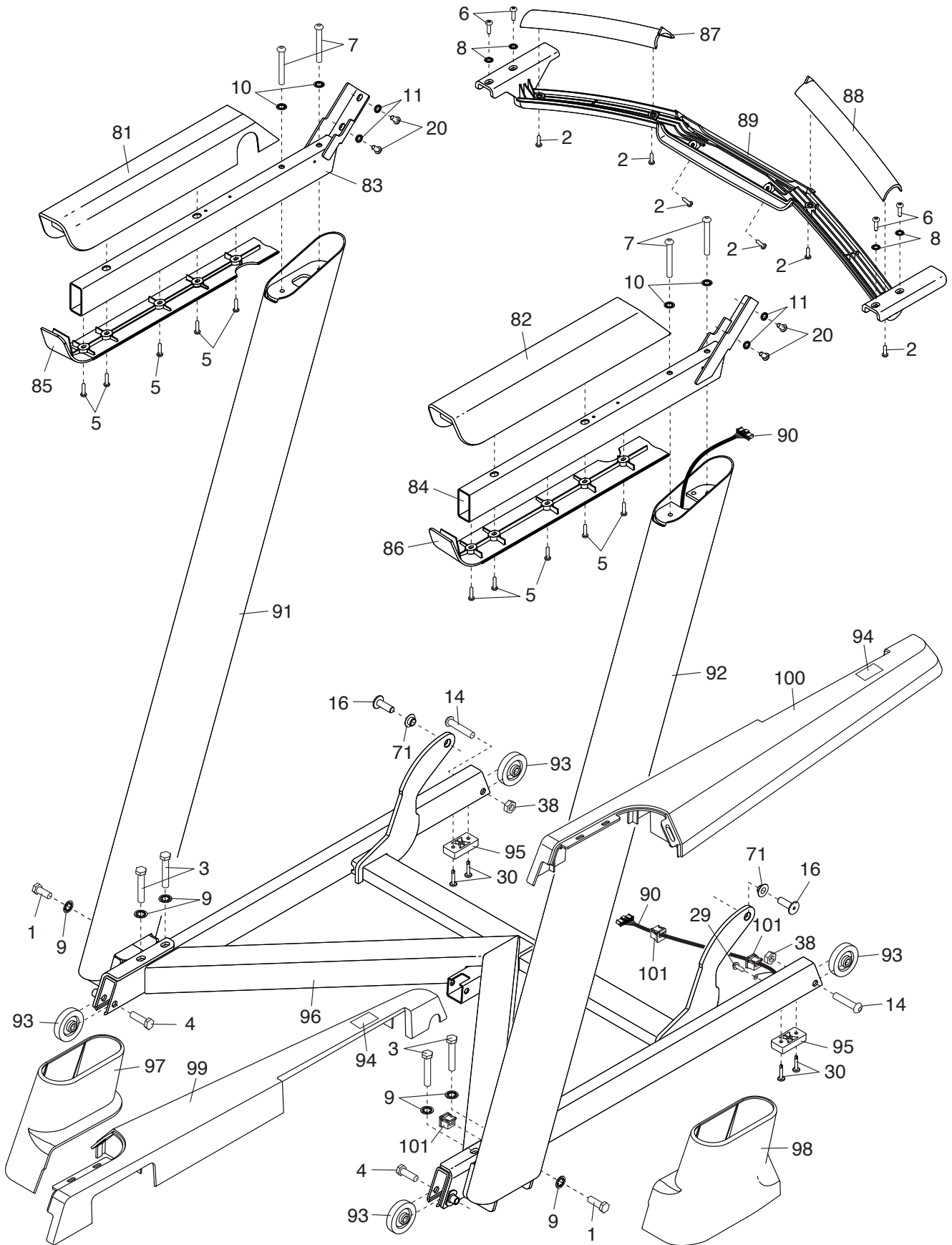

EXPLODED DRAWING D

Model No. PFTL12820-INT.2 R0521A

